

Palmako

LEMEKS GROUP

PREMIUM PRODUCT LINE
**NEW!
MODERN
LOOK!**
INNOVATIVE GLULAM WALLS

Bringing joy to the garden



OUR STORY

We are all searching for a balance in life. The fast pace of modern life forces us to constantly move faster, higher and further. Yet we still have an inner need that directs us to seek true meaning, deep rest, and slow happiness. Nowadays, finding peace of mind is a big challenge.

Often, it is difficult to find a calm space where you can rest from your daily struggles and just let things be as they are. Palmako aims to help create this space for you. Your garden is a place where special moments are stored. It is a place to rest, to deeply relax and to spend time with your loved ones. Here, you will connect with your true inner essence, restore your strength and composure in order to face new challenges again.

Palmako's eco-friendly wood products are designed to make your garden a special place in your life. Palmako does not only produce garden houses, nor is it limited to complete garden solutions. Palmako produces the joy of being and creates a cozy garden space where you can regain your strength or have a great time with your family and friends.



Modern and innovative



GRACE FAMILY BY PALMAKO

Palmako's new Modern Look Grace family houses are born from constant unrest to create something new and exciting. These cabins are extraordinary due to the innovative solution for wall construction - a special profile of glue laminated timber wall panels. Glue laminated timber is a stable and durable base material, that is also wonderfully easy to set up. The creation of such products has become possible, since Palmako's investment into the new fully automatic production line of laminated timber.

New innovative garden house family has four beautiful sisters: Grace 8.1+4.1 m², Grace 8.1+8.1 m², Grace 12.4+4.1 m² and Grace 14,5 m², which differ only in size and purpose. Why not create a cozy home office in a small cabin with a shorter canopy roof or use the Grace with a longer shed as a sauna or pool house. Grace 12.4+4.1 m² with two rooms is perfect for accommodate friends or relatives. The largest Grace has probably most functions among all sisters.

Simple and minimalist design of the Grace family houses is suitable for people who acknowledge timeless quality and uniqueness of environment friendly products that last. For people who understand value of future – be it a father with practical thinking or a housewife who loves the aesthetic look. The graceful Grace brings joy into your garden.



FUNCTIONALITY INSPIRED BY GRACE HOUSES



Grace houses can be used for many purposes, here are some ideas for you to consider.

HOME OFFICE: Quiet place for working from home. Perfect home office with opportunity to work outside in fresh air under roof overhang in case of nice weather.

WINTERGARTEN: Capacious room just for taking time for your own or sitting and relaxing with your family or friends.

EXTRA ROOM: Spacious house to store things that cannot fit anywhere else. Extra storage place can sometimes blow our mind with its usefulness.

POOL HOUSE: Having some snacks or listening to the music in pool house and off you go jumping into the pool! After swimming great place to warm yourself.

LEISURE HOUSE: Cozy garden space where to regain your strength or have a great time with your friends and family.

GUEST HOUSE: Guests will thank you sincerely after they have spent time in a special Grace house in your garden paradise.

OUTDOOR COOKING: Why not to cook for your family or friends in Grace and enjoy the food outdoors under roof overhang.

PERSONAL GYM: Set up a personal gym, turn on the radio and take care of your fitness.

PERSONAL MOVIE HOUSE: Awesome idea to make an evening with your family or friends memorable – turn off the lights, pull the curtains and start a movie night!

POP-UP CAFE: Serve your clients delicious cupcakes and coffee. They will visit you again in such a cozy little pop-up cafe!



All Modern Look garden houses use innovative glue laminated wall panels. Lifting height of 518 mm makes an installation of the house easy and fast.



Modern wall corner connection of glue laminated wall panels are fixed with dowels and secured by screws.



Stable and weatherproof corner and log connections are guaranteed by using self-adhesive sealing.

INNOVATIVE GLULAM WALLS

Laminated timber combines the modern technology and centuries-old tradition of using wood as a construction material. Wooden houses present a healthy living environment and natural qualities of the timber have been hereby increased remarkably.

Palmako brand new Grace family houses use laminated timber wall panels, which are stable and weatherproof and make building wonderfully simple. Glue laminated wood ensures, that the building does not settle so much after completing. Unlike conventional laminated timber houses, new wall panel profile is unique - it is thin and high and the tenon joints stay tighter by being covered with a slat.

To reach the full height of the house, only 4 panels on top of each other are needed. When the lifting height of an ordinary milling beam is 114 mm, the new wall panel has a lifting height of 518 mm, which means that the surface of the wall remains smoother. Laminated timber is stable (no expansion-contraction or distortion), has a beautiful structure (no fissures or defects) and has a good fire resistance and heat insulation.

GRACE 8,1+4,1 m²

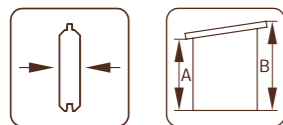
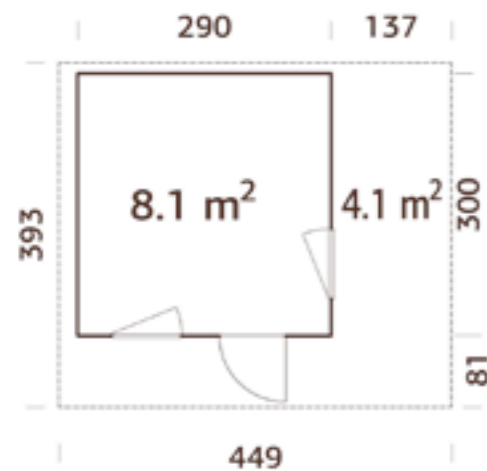

56 mm

A: 215 cm
B: 258 cm

MODEL SPECIFICATIONS

Wall measurements: 290+137x300 cm

Gross ground area: 8,7+4,1 m²

Volume: 18,8 m³

Door/window type: Living

Door/window glass:

Double toughened glass, 4-18-4 mm

Window opening measurements: 50x150 cm

Door opening measurements: 70x193 cm

Door sill: high quality classy oak-aluminium combined door sill

Roof boards: 19 mm

Roof area: 17,5 m²

Roof gradient: 5,0°

OPTIONAL

Roofing felt (underlayer): 3 rolls, SBS roofing material:
3 rolls, roofing nails, EPDM, rain gutters, additional door
and window.

GRACE 8,1+8,1 m²

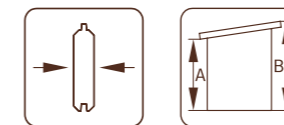
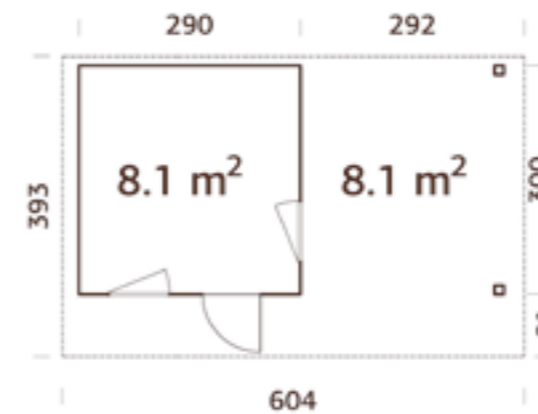

56 mm

A: 215 cm
B: 258 cm

MODEL SPECIFICATIONS

Wall measurements: 290+292x300 cm

Gross ground area: 8,7+8,1 m²

Volume: 18,8 m³

Door/window type: Living

Door/window glass:

Double toughened glass, 4-18-4 mm

Window opening measurements: 50x150 cm

Door opening measurements: 70x193 cm

Door sill: high quality classy oak-aluminium combined door sill

Roof boards: 19 mm

Roof area: 23,7 m²

Roof gradient: 5,0°

OPTIONAL

Roofing felt (underlayer): 5 rolls, SBS roofing material:
5 rolls, roofing nails, EPDM, rain gutters, additional door
and window.

GRACE 12,4+4,1 m²

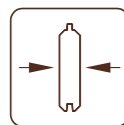
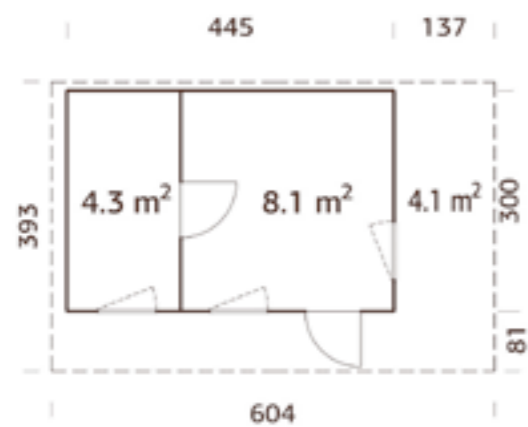

56 mm

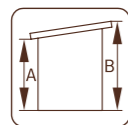

A: 215 cm
B: 258 cm

MODEL SPECIFICATIONS

Wall measurements: 445+137x300 cm

Gross ground area: 13,4+4,1 m²

Volume: 28,8 m³

Door/window type: Living

Door/window glass:

Double toughened glass, 4-18-4 mm

Window opening measurements: 50x150 cm

Door opening measurements: 70x193 cm

Door sill: high quality classy oak-aluminium combined door sill

Roof boards: 19 mm

Roof area: 23,7 m²

Roof gradient: 5,0°

OPTIONAL

Roofing felt (underlayer): 5 rolls, SBS roofing material: 5 rolls, roofing nails, EPDM, rain gutters, additional door and window.

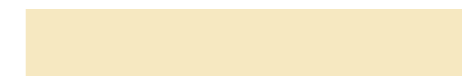

GRACE 14,5 m²

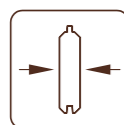
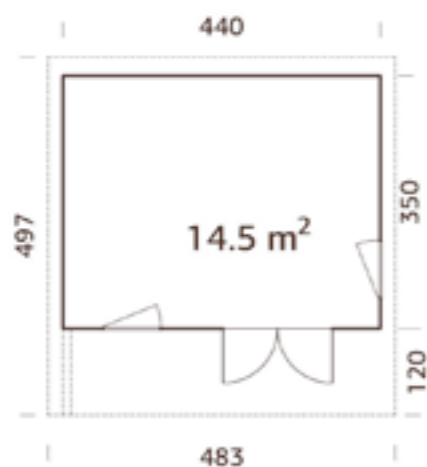

56 mm

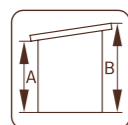

A: 227 cm
B: 279 cm

MODEL SPECIFICATIONS

Wall measurements: 440x350 cm

Gross ground area: 15,4 m²

Volume: 35,2 m³

Door/window type: Living

Door/window glass:

Double toughened glass, 4-18-4 mm

Window opening measurements: 50x150 cm

Door opening measurements: 150x188 cm

Door sill: high quality classy oak-aluminium combined door sill

Roof boards: 19 mm

Roof area: 24,0 m²

Roof gradient: 5,0°

OPTIONAL

Roofing felt (underlayer): 7 rolls, SBS roofing material: 7 rolls, roofing nails, EPDM, rain gutters, additional door and window.

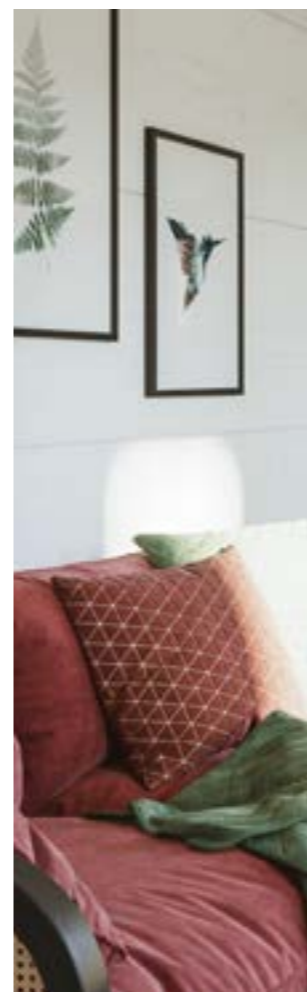



Premium quality windows and door

The quality of the Grace houses doors and windows is the best in its class. Laminated timber door frames, high quality classy oak-aluminium combined door sill, double toughened glass and premium lock system. Windows are with one-hand tilt-and-turn system with double toughened glass.

Paint finishing options

The doors/windows can be delivered from the factory with paint finishing, and the colour shade can be chosen from RAL colour chart. The most popular colour tones are:



NB!
Colours as shown in the catalogue may vary from the actual colours.



Foundation joists and floor boards

Foundation joists of the Grace houses are treated to guarantee long lifetime to the basis of the house. Solid 28 mm floor boards and floor slats are included in the house kit.



Roof construction

Strong glue laminated rafters carry 19 mm roof boards. To ensure the water resistance of the roof, we strongly recommend to use solid EPDM roof covering for these pent roof house models.

OPERATING GRACE DOOR

② Lift up the handle.

Lifting up the handle activates hook/wedge bolts, which helps to stabilise the door position, allocate the door weight evenly across the hinges and the door frame. This ensures long and functional lifetime to your door.



NB! In this position (handle lifted up) **the door is not locked!** As soon you push down the handle, door opens.

① Close the door from inside or outside.



③ Lock the door.



NB! Without lifting the handle you are unable to lock the door (both from outside and inside).

DESIGN YOUR OWN BESPOKE GRACE MODEL!

We recognise that sometimes our customers have very individual needs and wants. At Palmako we will always try to strive and meet these needs where possible. The nature of our innovative design for the Grace family allows us to be flexible with design requirements and offer a truly unique bespoke service.

You can make your building smaller or larger than our standard. If you want more undercover outside space you can design your own canopy to suit your needs. The strength of our laminated timber enables us to offer a more open plan solution than standard log cabins and can be the ultimate choice for those looking for that little bit extra from their garden retreat.

Also available with our bespoke service is a choice of additional windows and doors. As well we offer pre painted windows and doors with our bespoke models with a RAL colour chart to choose desired colour schemes.

Please share your ideas and thoughts with Palmako's sales people or representative resellers - we will strive to help realise your dreams!

Examples of two bespoke Grace houses already rejoicing their owner:

Grace 12,4+4,1 m² (double door)



Grace 11,5 m²



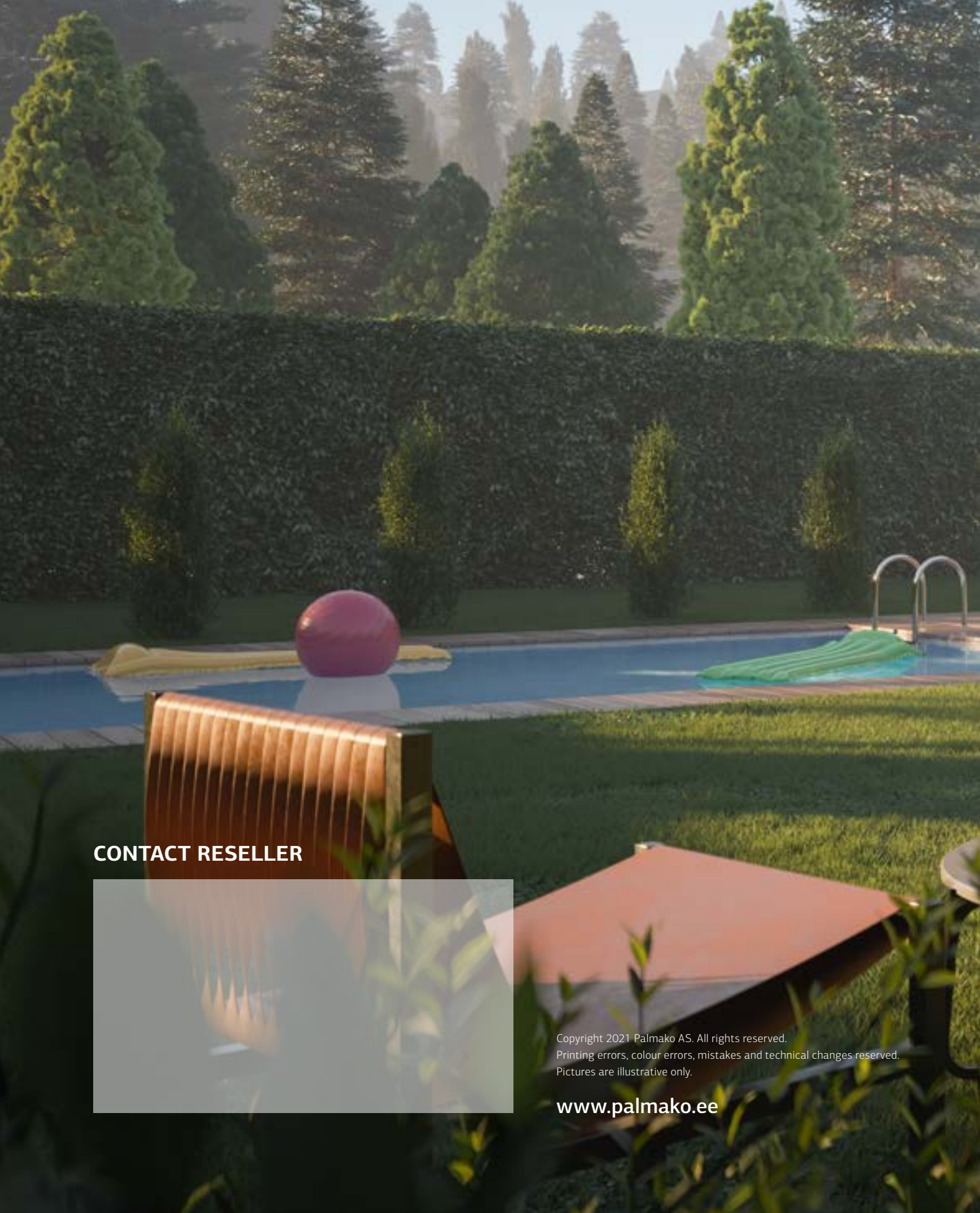

CONTACT RESELLER



Copyright 2021 Palmako AS. All rights reserved.
Printing errors, colour errors, mistakes and technical changes reserved.
Pictures are illustrative only.

www.palmako.ee